

# 選手交代用メモ帳

使い方

以下のメモ帳を印刷し一つずつ切り取ってください。選手交代時に監督から言われたポジションの順に矢印を引きます。ベンチメンバーとの交代時は名前を横線上に記入してください。必要に応じてスコア記入者に球審が記入したメモ帳自体を渡してあげると喜んでくれるかもしれません。

[例]1が6、6が4、4が7、7が変わって、  
ピッチャー佐藤(矢印の数字は書き順)

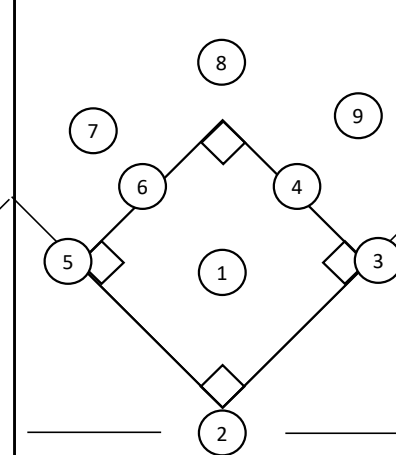
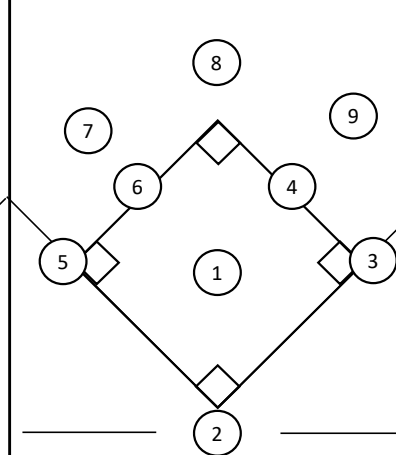
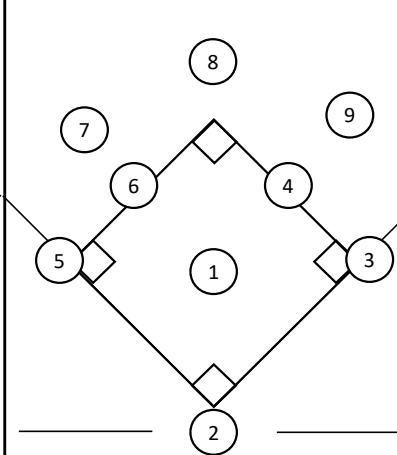
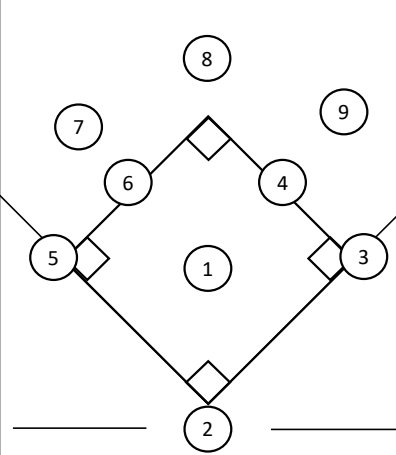
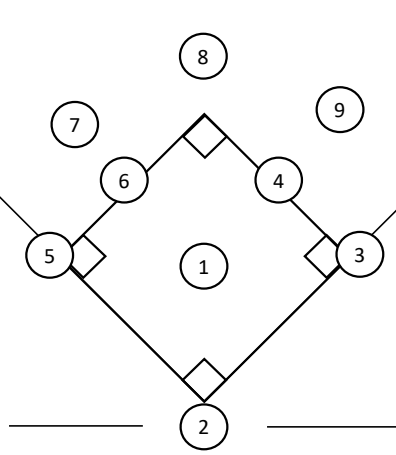
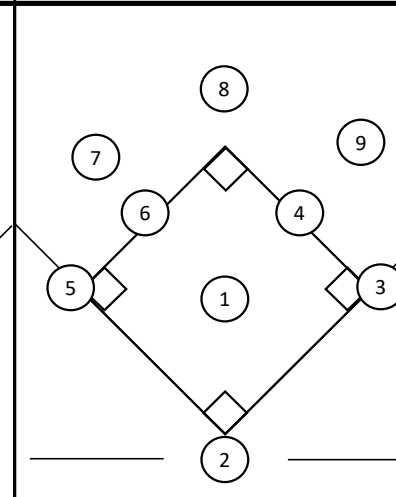
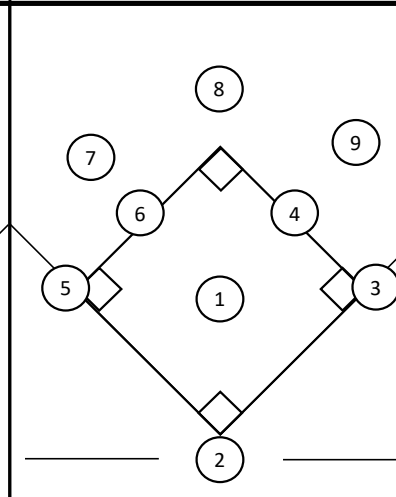
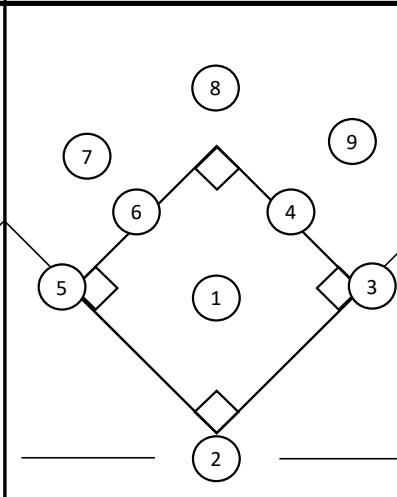
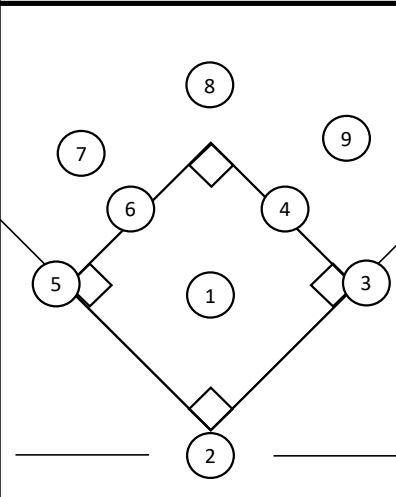
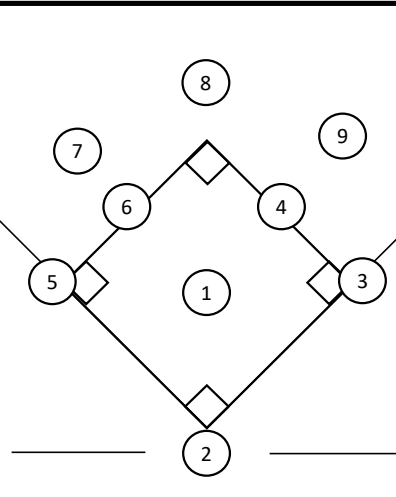
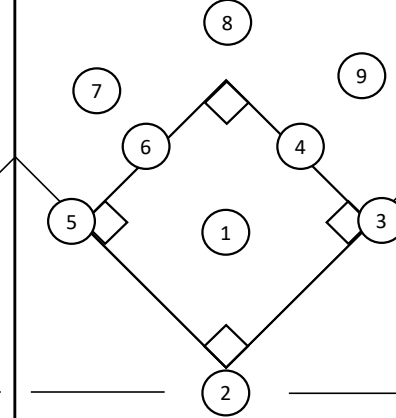
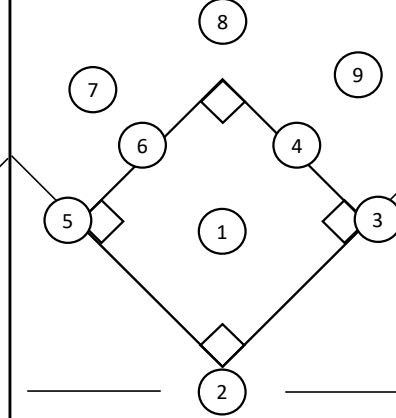
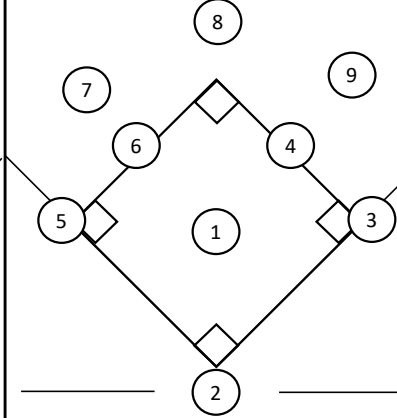
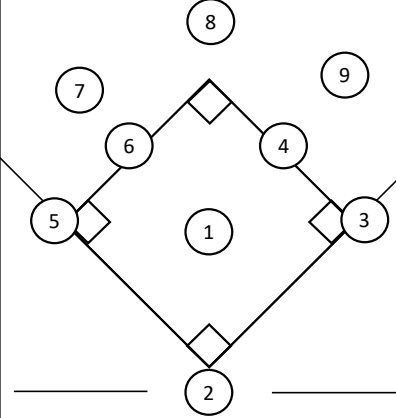
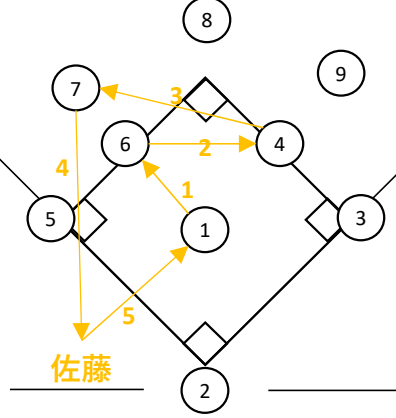

# 選手交代用メモ帳

使い方

以下のメモ帳を印刷し一つずつ切り取ってください。選手交代時に監督から言われたポジションの順に矢印を引きます。ベンチメンバーとの交代時は名前を横線上に記入してください。必要に応じてスコア記入者に球審が記入したメモ帳自体を渡してあげると喜んでくれるかもしれません。

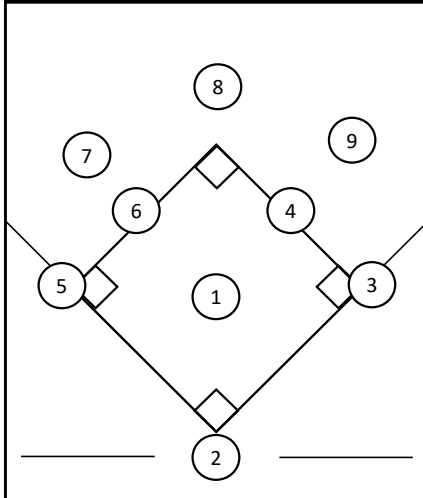
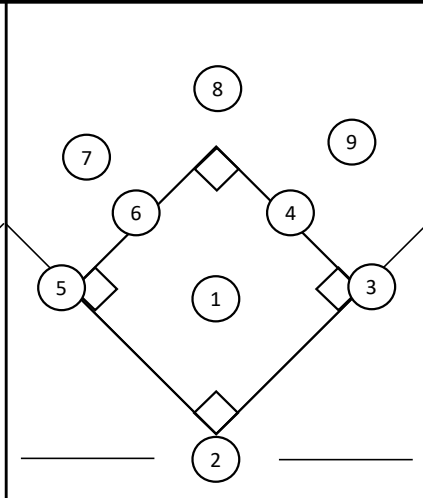
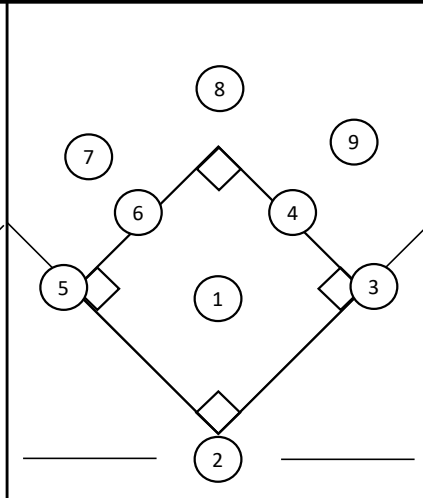
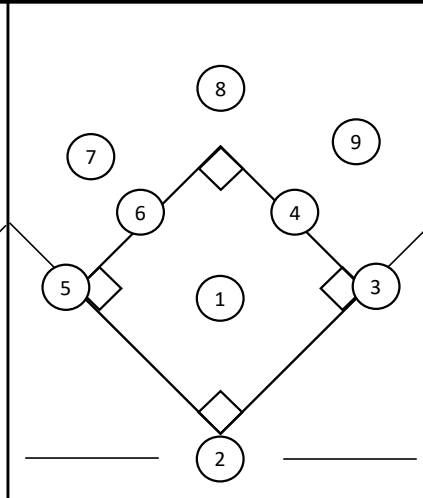
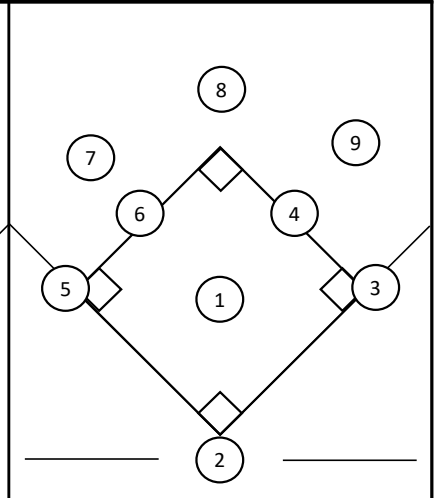
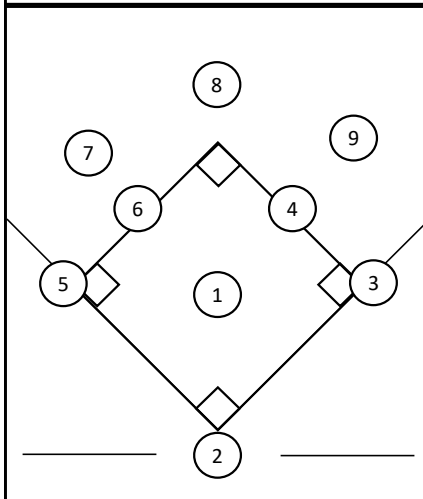
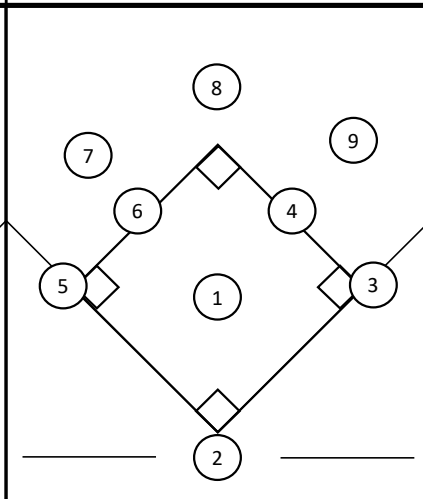
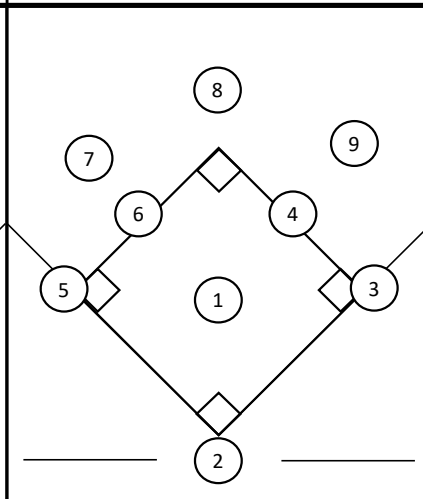
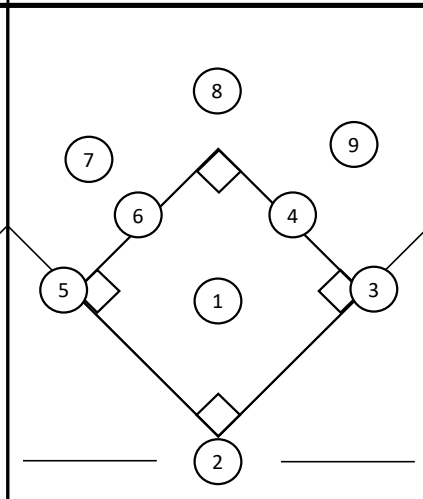
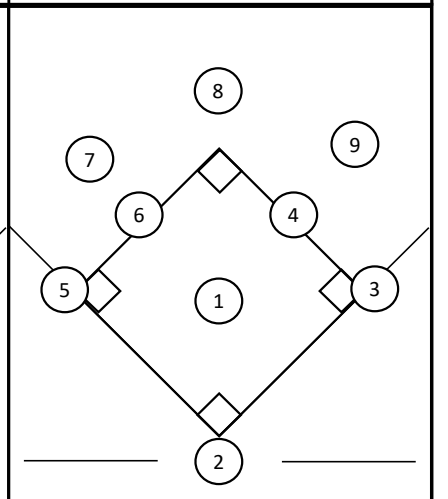
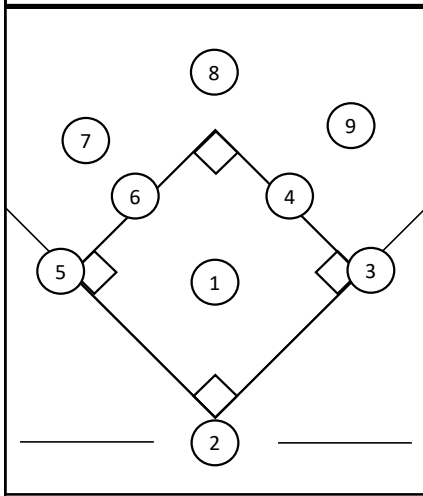
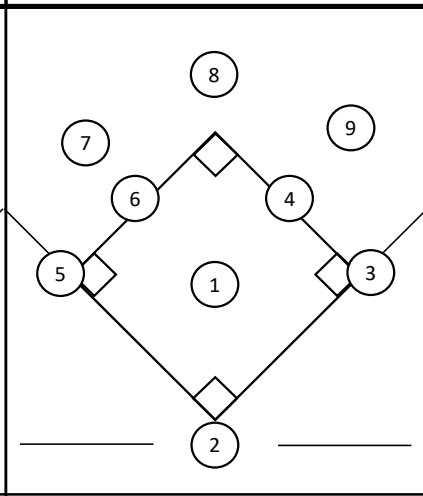
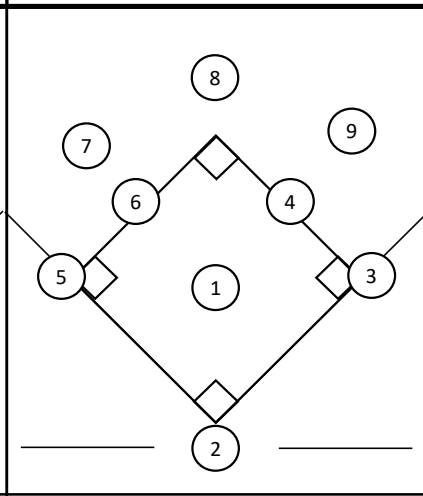
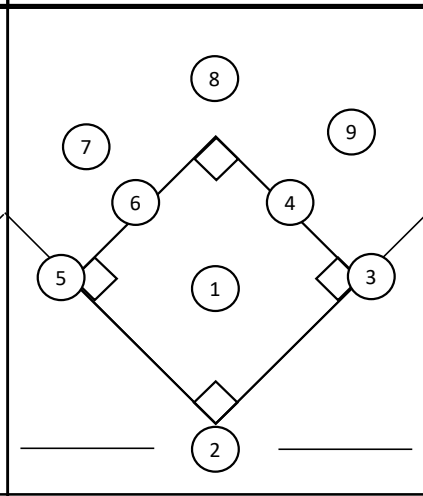
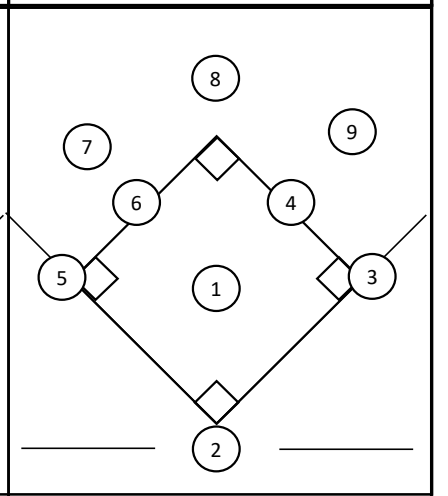
|  |   |  |   |   |
|--|---|--|---|---|
|     |     |     |     |     |
|   |   |   |   |   |
|  |  |  |  |  |